

ATX



LED

<http://atx-led.com>

AL-WS-DR2C v2

Decorator switch style
Constant Current LED / Fans
driver and dimmer

56 watt 3-Way DALI CCT



Product Description - AL-WS-DR2C wall switch

This switch operates just like any standard residential light switch – however it takes 48-54v DC instead of 120VAC, and directly drives up to 56 watts of LED bulbs without additional drivers. This Decorator style switch in a standard residential style outline fits into any home, looks like any switch yet meets NEC article 411 for Low Voltage lighting.

Stand alone it operates as a simple switch for up to 10 single color or 5 tunable white LED's. For example, 8 LEDs with 6 watts each can be connected, 2 sets of 4 in series to each of the 2 outputs on this switch / dimmer device. Or 4 LEDs with tunable white. Use AWG 20/2 to connect to your LEDs in series – no CAT-5e tools are required to wire this device. Use AWG 16/3 or 18/3 to bring 48v (or 24 to 52 volts) and earth ground from a central power supply over to the switches. Daisy chain up to 100 watts on one home run – minimizes the number of home runs per project.

A proven rocker switch and brightness slider leverages mass production of decorator switches - now for Low voltage applications – a casual user requires no training, no App, no Internet to use this switch. Perfect, flicker free dimming from off to 0.1% to 100%. No network setup is required. Temperature feedback assures excellent dimming. Max current of 660 mA allows up to 28 watts per channel – two channels are provided for 56 watts total in single color mode.

For 3-way operation – a simple 2 wire link with AWG24 or better allows 2, 3, or an unlimited number of switches to control one set of LED's. Any single pole switch found at Home Depot can be used to add a 3-Way remote switch, or dual pole switch for an unlimited number of switch points. Momentary or rocker switches can be used. The AL-WS family includes many switch options.



AL-WS-DR2
DALI bus and 56 watts



AL-WS-010v
DALI bus and 0-10v



AL-WS-Carro
Ceiling Fan Motor



AL-WS-DR1
Low cost 24 watt driver



AL-WS-M
Switch for 3-way
Momentary

Specifications

Power connectors (pass thru)	Spring loaded connectors (2 pairs) for AWG 16-20 wire – pass thru
LED constant current output	660 mA per channel – 2 channels Spring loaded connectors (2 pairs)
Dimming range	100 uA to 660 mA, 3000 steps
Input voltage range	44v to 54 volts (power for LEDs)
Standby power consumption	200 milliwatts
Conversion efficiency	Over 95%
Protection	Reverse protection and static protection, short circuit and overfoltage
Operating Temperature	0°C ~ 40°C
Size (US Style 1 gang)	108H (metal) 70H x 34 D x 42 W mm
Dimming	100% to 0.1%
FCC and interference	All outputs are RF filtered for minimal interference
Maximum output voltage	$V_{in} * 85\% = 43v @ 51V_{in} \quad 46v @ 54V_{in}$
Minimum output voltage	6 volts - self calibrating
Strip LED support	Autodetect 12v, 24v, CV strips MEPT mode with 48v CL strips
Hot Swap	Yes – can unplug and connect LEDs with power applied.
N-Way input (Vb to DA+)	simple contact for 3-Way – short to turn on
Vb	Power for Tandem mode
DA+ (IEC 62386 bus)	DALI bus connection – 1 mA required
FAN control with Timer	48v ATX LED Exhaust Fans
LED Timer	Configurable auto off

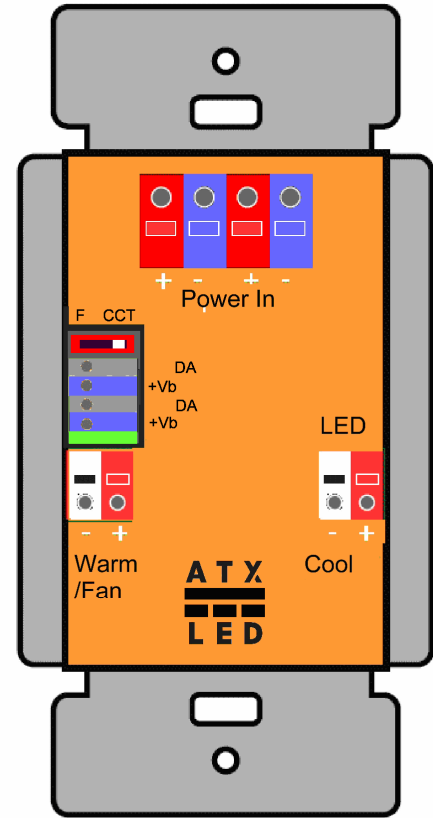

See <http://atxled.com/How2> for wiring instructions

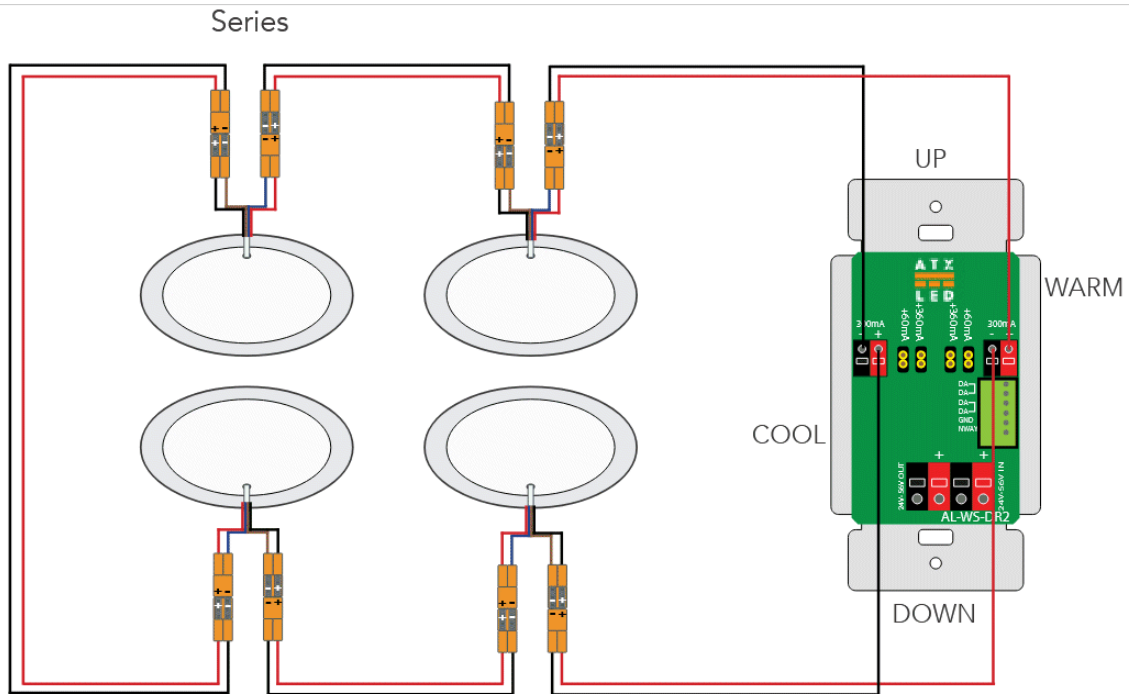

Powering the AL-WS-DR2 family

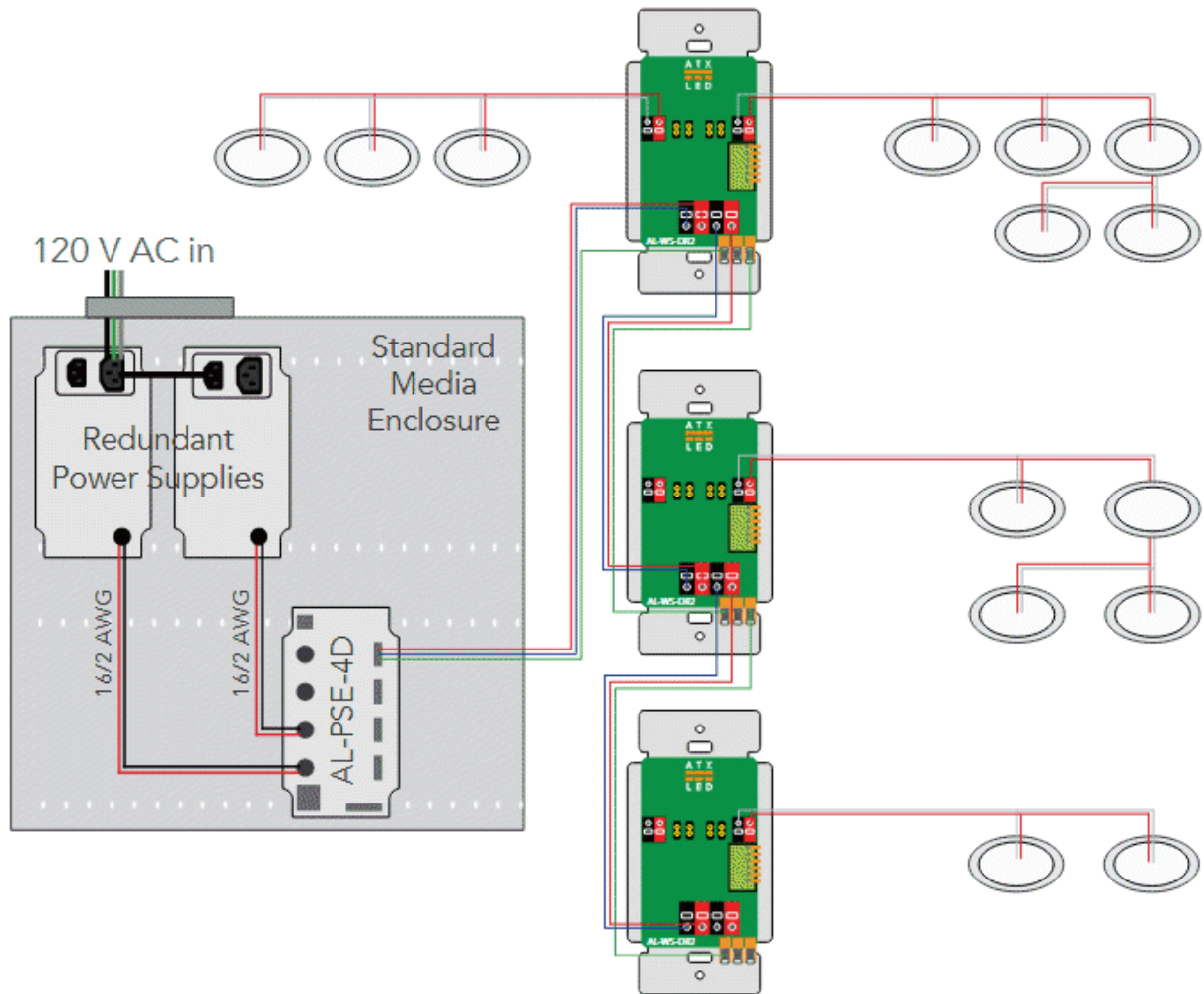

Power the switch via the Power input connectors, 48 to 52v is recommended. You can pass power thru from one set of power connectors to the other to avoid wire nuts in the box, up to 2 amps. When used with a 51 volt supply, voltage drop of up to 3 volts (60 ft of AWG18 wire) has no impact even with 50 watts of LED loads.

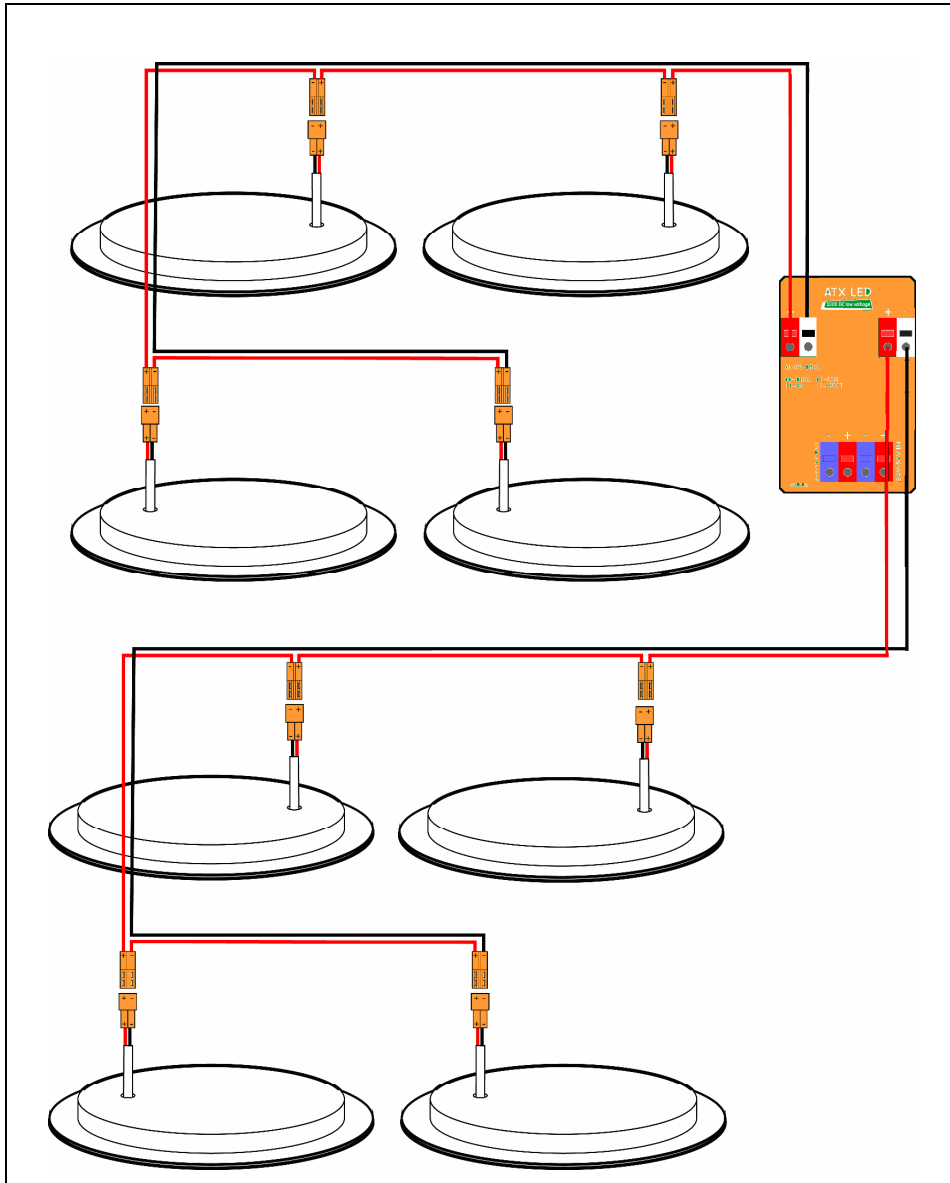

Up to 8 LEDs with one color temperature

Green 18/2 wires go the 2 sets of 4 LEDs each (in series)

The LEDs are wired in series

The simple strip and poke OJ-606 connectors are easy to install in ceilings.

If you only cut the Red wire – you can save time and work by wiring as shown at left – just 1 cut, 2 strips and insert.

Conventional wiring need 9 strips and 3 wire nuts per can.

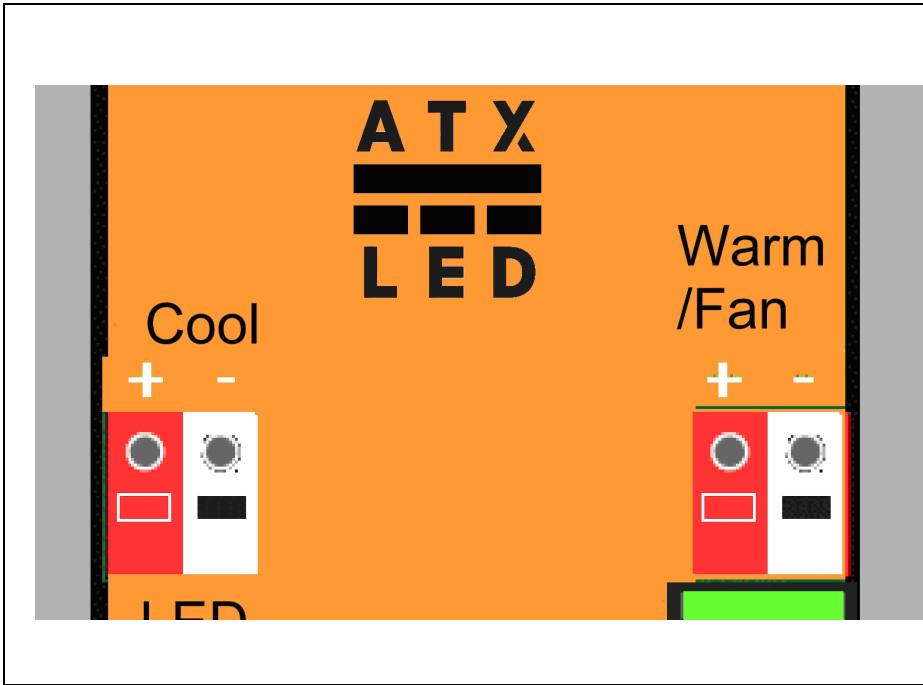

Detail of DR2C

The Red/White connector is each string of LEDs or FAN

From 1 to 4 tunable White LEDs can be wired in series

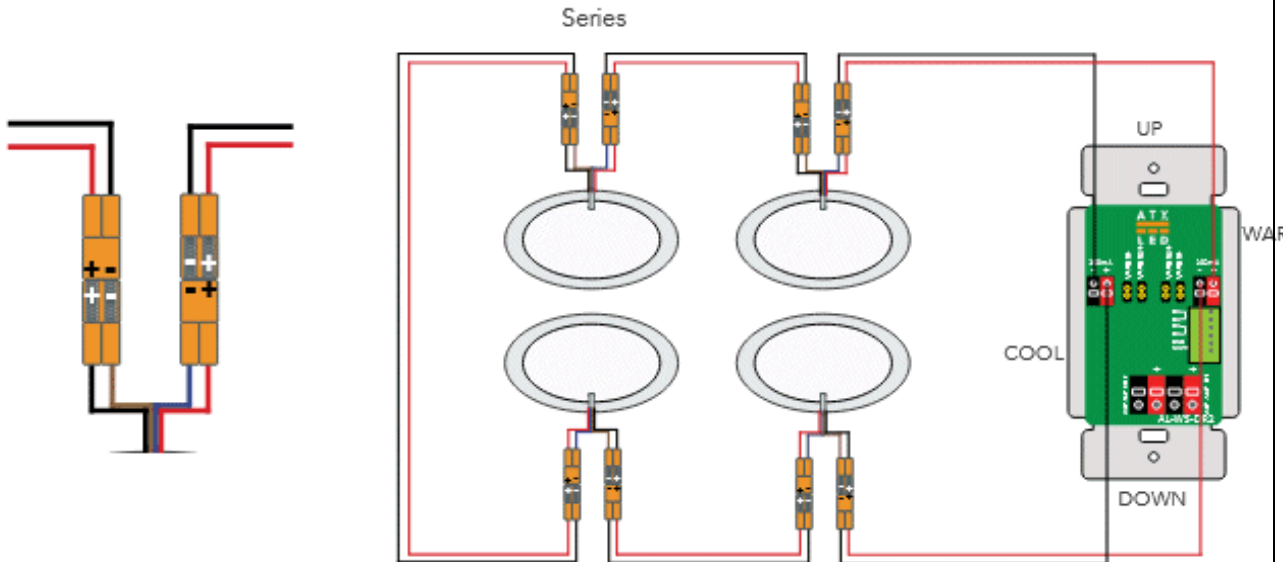

Ceiling Prewire for CCT

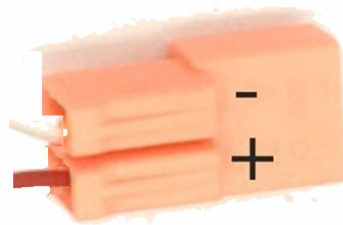

C +
W -

Down to next LED

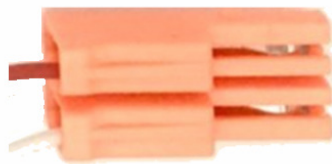

W +
C -

UP to Switch

For up to 5 Tunable White P023R6 LEDs – use the above diagram as an example. The Orange connectors go to the first junction LED position – jumper up to 4 LEDs together with simple 2 wire 18/2 jumper between the LEDs. See the How2 wiring guide for more info.

Basic wiring and operation

By default – the AL-WS-DR2C operates stand alone – no internet or hub is required. Connect one or both LED outputs to your LED's or fan Use 18/5 for the home run to assure upgrade options

Constant Current LED operation

The AL-WS-DR2C with a 54v supply can power up to 10 standard LEDs with 660 mA each – connect 1 to 5 in series to each side – the count does not need to match.

With a 48v supply it can power up to 8 standard LEDs with 660 mA each – connect 1, 2, 3 or 4 in series to each side – the count does not need to match.

AL-SL-48v Strip LED operation

Watt /ft	Tunable Color Temp (CCT)	Fixed
1.5	16.4 ft (5 mtr)	32.8 ft (10 mtr)
2.0	12 ft	24 ft
2.5	10 ft	20 ft
3.0	8 ft	16 ft

Auto Calibration – First time Power up

Each time an AL-WS-DR2 turns an LED on, it tests if the connection has been changed, light added, light removed or light replaced. If a change is detected, the switch will recalibrate itself. This is a sequence of light levels that determine the features and abilities of the connected LEDs. It can detect Constant Voltage LEDs, Constant Current LEDs, LED strips and Fans. This also occurs when a new switch is installed for the first time. Please wait 2 minutes after initial power on, or after changing any LED, for the sequence to complete. Turn the LED off to complete the calibration. After that phase – the result is stored in on-board EEprom and will be updated for temperature and aging changes over time. You can force the device to factory defaults from the switch front if needed (see table below). After calibration – you should not experience calibration again.

Smart home and WiFi options available

For cloud management, Alexa and Google control, the AL-DR2C can be connected to the ATX LED Hub, allowing full scheduling and other controls, if the installer ran 18/5 cable. If 18/5 is not in the walls, or just one or two switches need to be online, then the upgrade path with the AL-WS-DR2W is recommended

Recommended ETL listed LED's

LED rated watts	Type	Model	Hole Size inches	LED rating	Max Count @54v	Total power output Watts @660 mA	Note
6	Flat Ceiling	P023R6	4	660 mA	10	60	2x 5 series
6	Flat Ceiling	P023R6-27/50K	4	660 mA	5	30	5 in series
12	Flat Ceiling	P02106-Q4C	6.25	660 mA	4	28	4 in series
12	Flat Ceiling	P023R11	6 .6	1440 mA	10	60**	2x 5 in series
12	Flat Ceiling	P023R11-27/50K	6 .6	1440 mA	5	30**	5 in series
6	Recessed	DL-120-Fixed	4	660 mA	10	60	2x 5 in series
6	Recessed	DL-120-27/5000K	4	660 mA	5	30	5 in series
6	Gimbal Spot	DL-125	4	660 mA	10	60	2x 5 in series
6	Bulb	E26-660mA	E26	660 mA	10	60	2x 5 series
6	Bulb	E12-660mA	E12	660 mA	10	60	2x 7 series
6	Bulb	E26-48v6w	E26	120 mA	12	72	12x Parallel
18	Vanity	LP24 inch	4	800mA	2	15	1 per channel
24	Vanity	LP36 inch	4	660mA	1	24	2x 2 in series
12	Linear	AL-SL-48v1.5w	-	1440mA	16 ft	24	2x 5 series
12	Linear	P023S12 CCT	-	1440mA	6 ft	30	2x 5 series
35	Trimless	TL-60	2.75	660 mA	5	30	
35	Trimless	TL-120	4	660 mA	5	30	
6	Outdoor Small	ODB6	5	660 mA	10	60	2x 5 series

*size 3 / 5 means 3 inch light source and 5 inch trim diameter

** these 12 watt LEDs will operate at 6 watts each when used with the DR2 at 660 mA.

Momentary or On/Off Main Switch operation

The main switch of the device can be either On/Off type or Momentary. On/Off has the dimmer on the right, Momentary is installed with the dimmer on the left. The difference is that each press of the Momentary style causes the light to turn On/Off.

Functions – Momentary Main switch

If your AL-WS-DR2 has a Momentary switch then use this table. Note – the slider should be on the left

Function	Seconds	How to trigger
On / Off	0.5 max	Push the switch down for under ½ second. The light will turn on and off each time you press.
Adjust Color Temperature	< 45	Hold the button down – move the slider. The Slider now controls the color temperature – each time you move the slider – the 45 second timeout is extended.
Reset to defaults: - Recalibrate the LED currents - Set switches to On/Off style	45	Press and hold the button for 45 seconds. The switch will enter self calibration mode the next time the light is turned on. Self Calibration will also be done if the number of LEDs attached changes. The switch method will change back to On/Off type
Wrong switch type: Restore to Momentary Operation	0.5 x 5	After factory default, press the button 5 times with less than 0.5 seconds each to change from On/Off to Momentary operation.

Functions – On/Off style Main switch

If your AL-WS-DR2 has an Up/Down On/Off switch then use this table. Note – the slider should be on the right.

Function	“Flips”	How to trigger
Wrong switch type: Changing operation to Momentary	5	After a factory reset - press a momentary switch 5 times briefly to program the device for momentary operation. Both the built-in and remote switches can be either On/Off or momentary. The face plate can be exchanged in the field if needed.
Adjust Color Temperature		If the LED is off – move the slider. The light will turn on and you can adjust the color temperature. After adjusting the color temperature – turn the switch ON, and you can adjust the brightness. Turn the switch off and the color temperature and brightness will be saved.
Reset to defaults: - waiting to calibrate - switches are On/Off type	8	Set the dim to low dim. Turn the switch on for 2 seconds. Now off and on 8 times, quickly, leaving it on after the last flip. The brightness will change to 50%, then go off The switch will enter self calibration mode and the lights will flash.

Setting LED Operational Modes

By default – the AL-WS-DR2C operate stand alone. Connect the dual LED outputs to your LED's. For up to 8 standard LEDs with 660 mA each – Set the CCT switch to Fixed. Connect 1 to 4 in series to each side – the count does not need to match. Total is $8 \times 660 \text{ mA} \times 44 \text{ volts}$ or 58 Watts maximum. With the P023R6, 8 LEDs is 48 Watts.

For up to 4 Tunable White LEDs, set the CCT switch to CCT. Use the above diagram as an example. The Orange connectors go to the first junction LED position – jumper up to 4 LEDs together with simple 2 wire 18/2 jumper between the LEDs.

The device is self calibrating. The first time it is installed, the lights will flash while the system is tested After that phase – the result is stored in on-board EEPROM and will be updated for temperature and aging changes over time. You can force the device to factory defaults from the switch front if needed.

Tandem Mode without an ATX LED Hub

The AL-WS-DR2C can operate in a Peer to Peer Tandem mode. Vb provides the peer to peer DALI power for operation without a hub. Jumper Vb to DA+. Between multiple AL-WS-DR2C - only the Yellow wire is needed. See photo. In this mode – all AL-WS-DR2C will have DALI address 16, and group 0 is enabled, packets are sent between AL-WS-DR2C on group 0.



Full DALI Operation

The AL-WS-DR2C normally is used locally. If connected to a DALI bus hub or master, it will operate as a AL-WS-DR2 – please see the AL-WS-DR2 for all details. Note – only the DA+ (Yellow) wire is required for DALI operation. Leave the Vb open unless in Tandem mode. By factory default – the device has address 16 – you will need to use the DALI Master to assign unique addresses to each AL-WS-DR2C

Tandem Mode – multiple AL-WS-DR2C in unison

The AL-WS-DR2C will transmit any change in level or state or CCT, via the DA+ pins to other devices using DALI broadcast commands. This allows advanced 3-Way dimming between many switches for very large rooms, but more typically 2 or 3 in a large living room with multiple egress points.

If connected to a DALI master – the switch can be assigned a short address. Once that is done, please see the AL-WS-DR2 data sheet for tandem mode operation, broadcast packets will not be sent. The ATX LED Hub is a quick way to configure this, but any DALI Master can be used as well.

In order to power the communication of the Tandem mode – connect one of the Vb point to one of the DA+ points. Once this is done – the other Vb and DA+ lines are the DALI connections. The yellow LEDs will show power.

Slider Operation

The Slider for dimming has 3 functions in this device.

- A) it changes the brightness of the LEDs when the switch is ON.
- B) it changes the color temperature if you have CCT enabled. Moving the slider with the light OFF changes the color temperature. Turn the switch on to exit color temperature operation
- C) it returns the switch to UP = ON operation. If the main switch is UP and you move the slider, the lights will turn on. This compensates for the 3-way effect that leaves the switch with the light on when the switch is down.

Fan Connection

A SLM70-48v or similar fan can be connected to the Right Led/Fan output. It will be automatically detected and operation will be in Automatic, manual or timer mode as described below in the N-Way section. The DR2 in fan mode has a 48 volt output and the SLM70-LVDC has a 100 uf input capacitor that allows it to be automatically detected. Fans with lower capacitance may not be detected.

Trouble Shooting

If the LEDs do not turn on at full brightness, or flash – please check common causes;

1. Flashing the first time the light is turned on, or if the number of LEDs per side changes, is part of self calibration, please wait 1 minute for this to complete.
2. If no light – then the number of series LEDs is exceeded. The forward voltage of the LEDs is too great. The delivered voltage is between 7 and 42 volts (with a 48 v supply) or 46 volts (with a 52 volt supply). Check the forward voltage of the LEDs and add them up. For example, a 6 watt 660 mA bulb is 9v.

if your LEDs add up to more than 42 or 46 volts - they will not turn on at full brightness, and might not turn on at all.
3. Cross wiring. If the + of one side is connected via the LED to the – of the other side – then the LEDs will cycle on/off every 4 seconds.
4. If CCT LEDs are used and the CCT switch is Off – the colors will not change, and the LEDs will operate at 12 watts instead of 6 watts – it could be intended by the installer to operate at 12 watts per bulb for example with a P023R11 6 inch fixture. Operating a 6 watt fixture at 12 watts. will decrease bulb life and could overload the home run to the power distribution panel.
5. If cable is used that is not copper (see CCA anywhere on the box ?) then there will be substantial loss in the wire. Please do not use CCA type wire of any kind
6. If the FAN does not turn on – note that the switch options need to be set to enable the FAN.

N-Way input Options and wiring

The N-Way input has several functional options. A simple low cost switch or alarm contact can be used to activate this. The options are: 3-Way, and Fan Control. Default is simple 3-Way.

3-Way Operation (On/Off remote switch)

Simply connect an AWG24 (solid CAT-3 or better is recommended) between the Vb and DA pins and a remotely installed AL-WS-M wall switch. If more control switches are needed – wire them in parallel. No controller is required; an unlimited number of switches can control one light. See our online application note for 3-Way switching.

Fan Switch Operation

Fan operation supports two types of switches, and also operation without a fan switch. Connect the AL-WS-M between Vb and DA – tandem mode is not supported.

For momentary switches

- A) Press to start: each press adds 5 minutes run time, enables automatic operation
- B) Press long to stop: press for 4 seconds and release to stop the fan, disables automatic operation
- C) Automatic operation: Each time the light is turned on, after 90 seconds the fan will turn on and stay on for 10 minutes and turn off automatically. Press for 4 seconds and release to stop the fan now and exit automatic operation. Press the AL-WS-M button while the light is ON to enable Automatic. Press the AL-WS-M button for 4 seconds while the light is OFF to disable Automatic.

For operation with no fan switch,

The DR2C defaults to follow mode – the Fan is on with the light, off when the light is turned off.

N-Way Operations

With the Momentary method enabled – each momentary short of the Vb to DA will toggle the light on / off. To enable this mode (if not already set) – use an AL-WS-M or RH-253 or similar momentary switch and press it 5 times after power is applied.

Remote Switch Functions – Push Button style

Function	Seconds	How to trigger
On / Off	0.5 max	Push the switch down for under ½ second. The light will turn on and off each time you press.
Remote Dimming	< 10	Press and hold the button to dim down, then up. To dim down again, release and press. Do not hold longer than 15 seconds.
Return to On/Off style	45 seconds	Should the switch get confused and act in toggle mode when the switch is On/Off – simply leave On for 15 seconds and the system will correct the error.
Changing from On/Off to Momentary	5	If a AL-WS-DR2 with a momentary switch is operating in On/Off style – then press the rocker 5 times briefly – 1 second between presses - it will switch to Momentary operation.



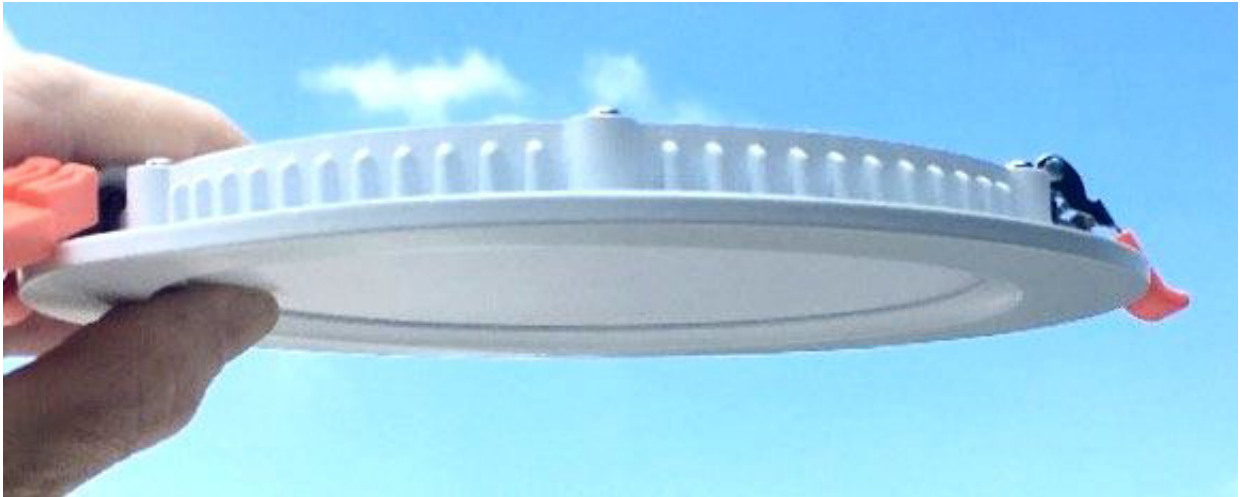

Remote Switch Functions – On/Off style

Function	“Flips”	How to trigger
Remote Dimming		Not supported
Changing from On/Off to Momentary	5	If a AL-WS-DR2 with a momentary switch is operating in On/Off style – then press the rocker 5 times briefly – it will switch to Momentary operation.
Return to On/Off style	45 seconds	Should the switch get confused and act in toggle mode when the switch is On/Off – simply leave On for 45 seconds and the system will correct the error.



Product Description - low profile long life LED fixture

The P023R series of LED fixtures are ETL listed and IC rated for direct contact with insulation – recognizing it's cool operating temperatures and distributed heat (no hot spots).

Trim Diameter	Color Temperature	Feature	Connector	Watts	Image
5	2700, 3000, 3500, 3850, 5000 K or tunable	Slim Disk	OJ-606	6	
7 ½	2700, 3000, 3500, 3850, 5000 K or tunable	Slim Disk	OJ-606	11.5	
4	3000 K or 3500 K	Gimbal	wire	6	See MS31008
5	3000 K or 3500 K	Spot	LeverNut	6	See DL-120
A60F Frosted	3000K, 3500K	Bulb	E26	6	
A60 Filament	2700 K, 3000K, 3500K, 4000K	Bulb	E26	6	
C35 Filament	2700 K, 3500K 4000K	Bulb	E12	6	
18 inch	2700, 3000, 3500, 3850, 5000 K or tunable	Linear	OJ-606	12	

ATX LED Product family

